

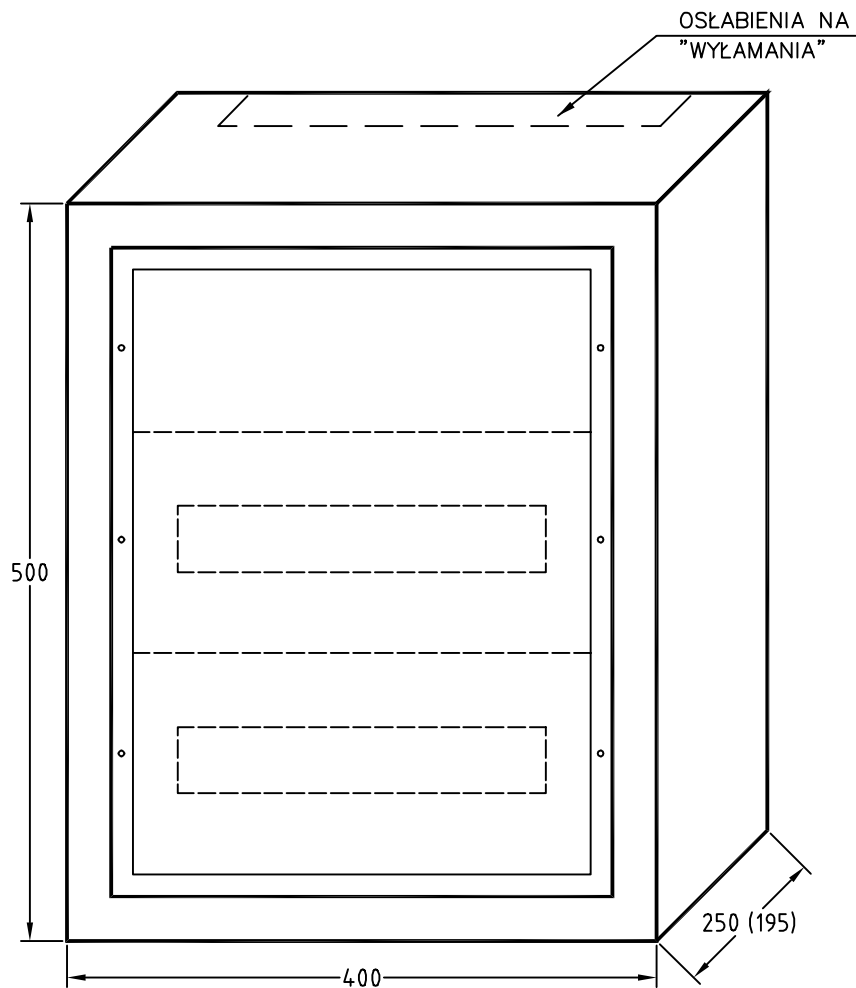

rys. 13



nr rysunku N2003A13/400		opis obudowa 2-rzędowa (30 modułów s=18mm) o szerokości 400mm, wysokości 500mm i głębokości 250(195)mm		 ul. Maciejowicka 36 BCE 70-786 Szczecin Polska www.bekazet.pl
nazwa system obudów Natalia 2003		kod katalogowy B13-00014	symbol N2003A 400/500/195	
data grudzień 2003	skala 1:5	kod katalogowy B13-00114	symbol N2003A 400/500/250	